

A

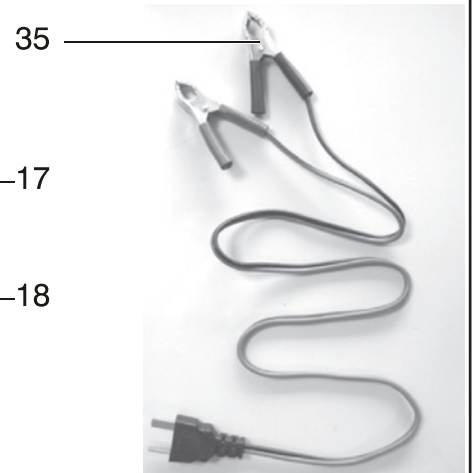

B

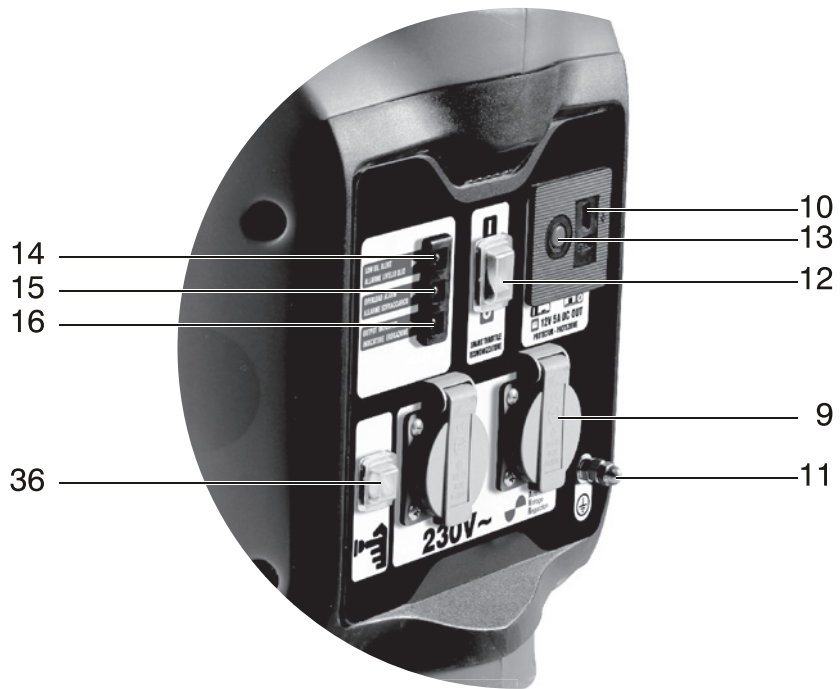
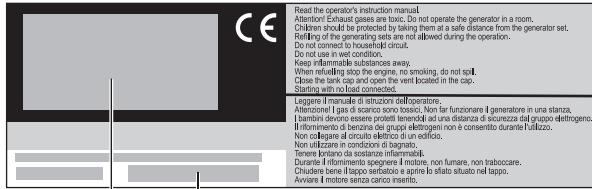

1 2



15

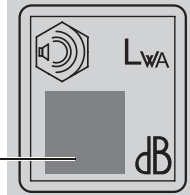

16

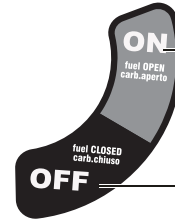
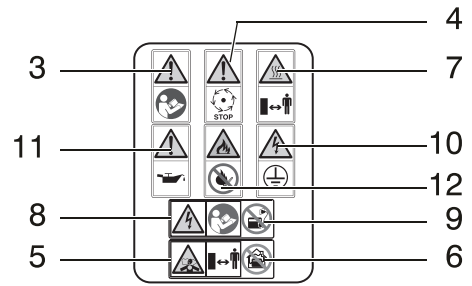

13

14

C

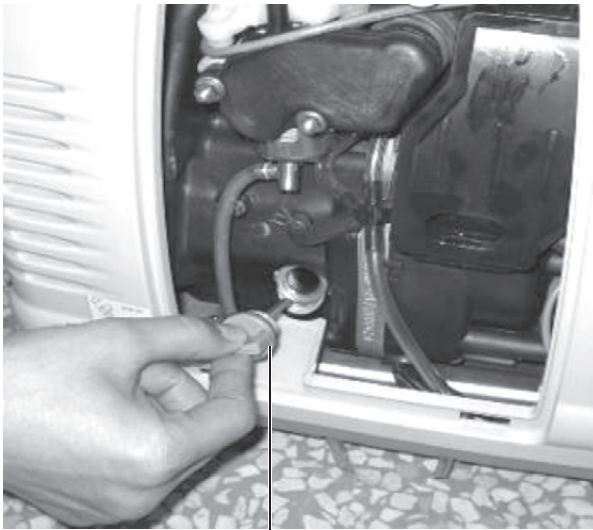

29

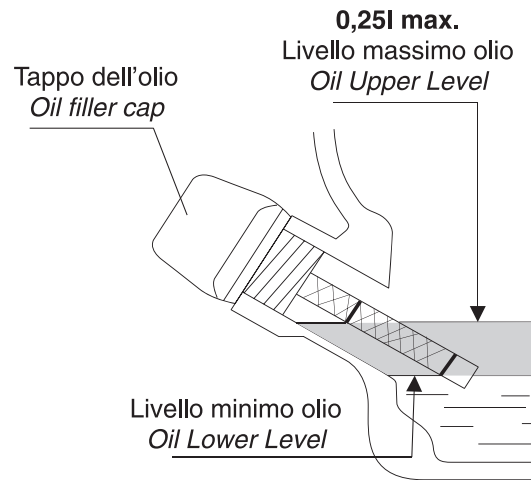

D



4



30

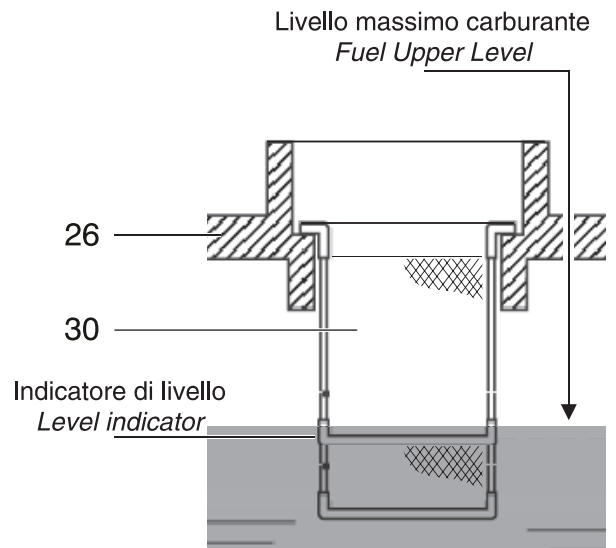
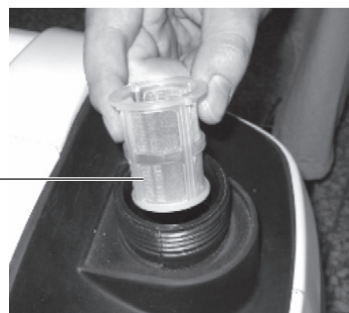

E

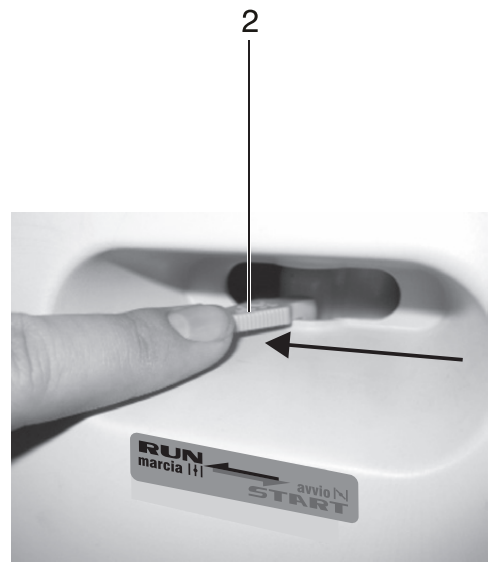
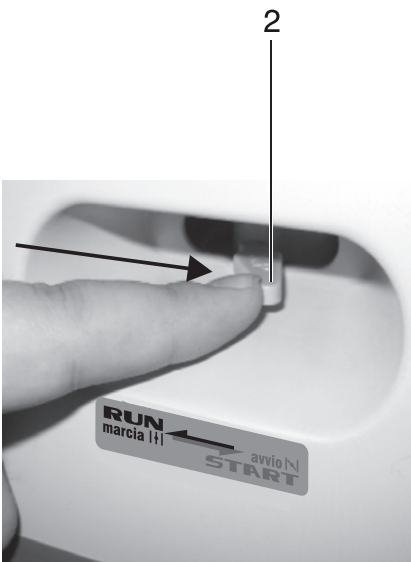
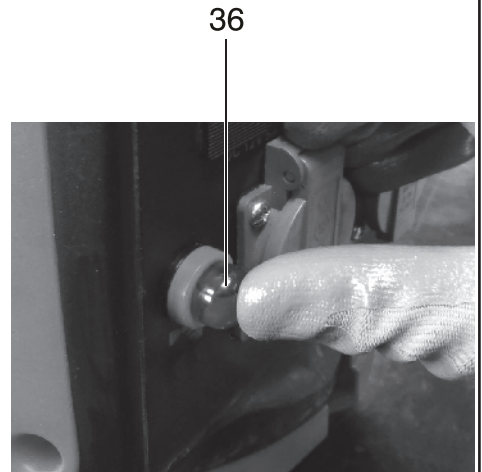
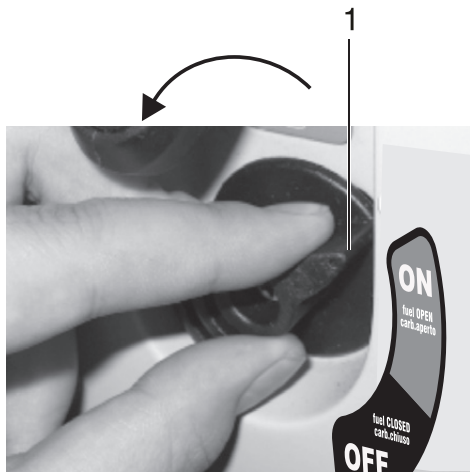
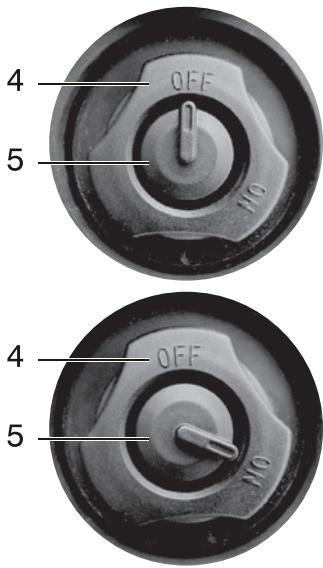

F

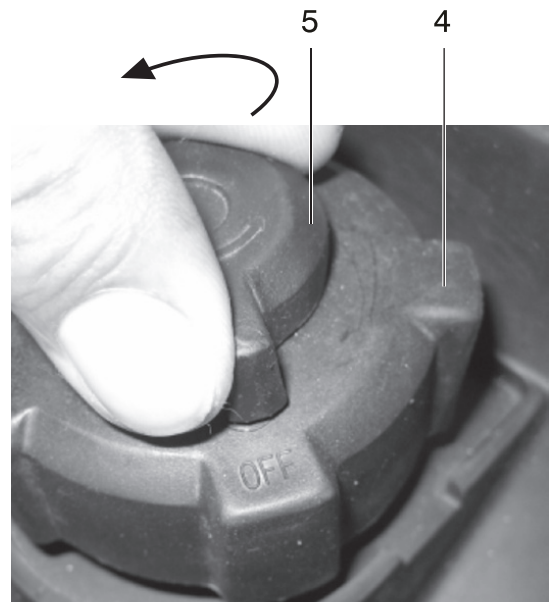

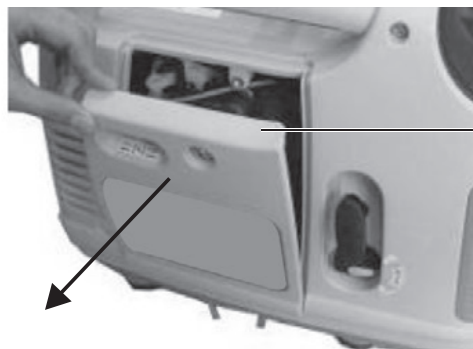
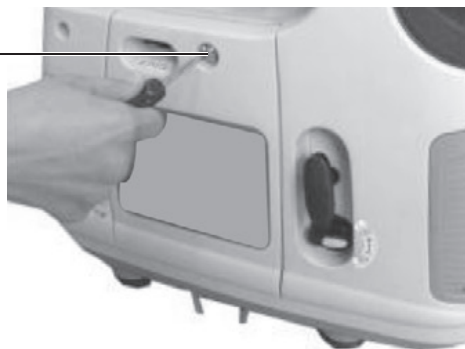
Gvite
screw

20

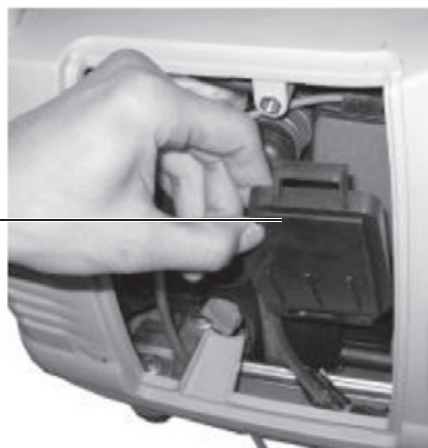

33



32

H

33

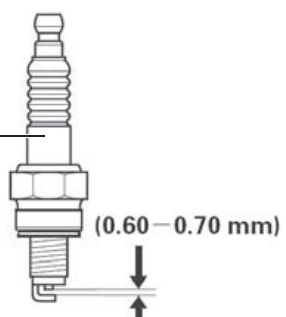

19

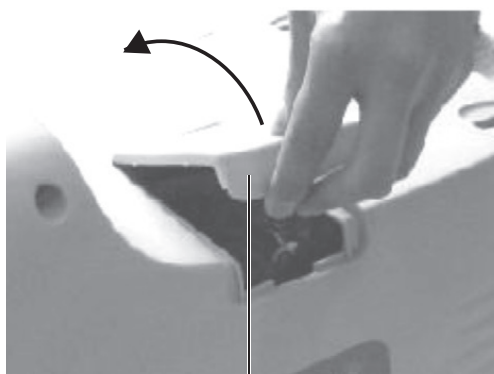

19

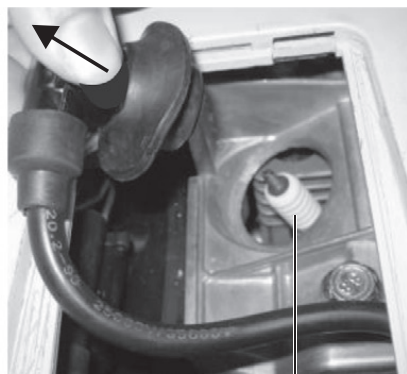

33

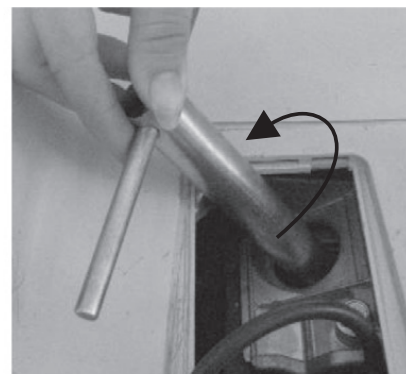

L



28
allentare
unscrew a little

22

tanica per benzina
fuel tank

M



18

4 viti
4 screws

vite
screw 17

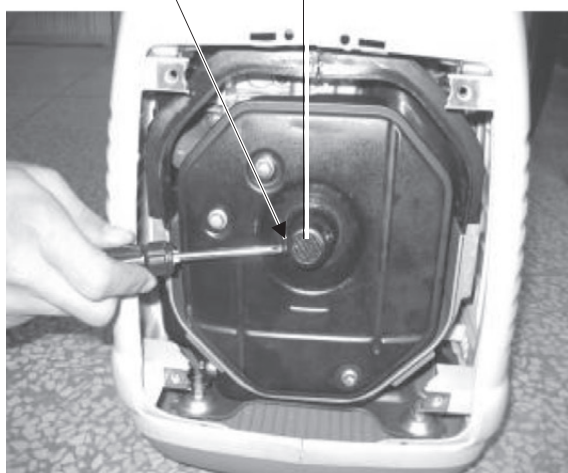

indossare guanti protettivi
wear safety gloves



DREAM 4000

- I** Generatore inverter silenziato monofase a benzina
GB Silenced single phase inverter generator with petrol engine

DATI TECNICI

Motore

1. Tipo di motore
2. Potenza motore
3. Cilindrata
4. Consumo carburante al 75% del carico
5. Capacità serbatoio
6. Consumo olio max
7. Quantità olio motore
8. Candela tipo

Generatore

9. AC uscita: tensione e frequenza nominale
10. AC uscita: corrente nominale
11. DC uscita: tensione nominale
12. Potenza max secondo ISO8528 (PRP) a $\cos\phi$ 1
13. Classe prestazioni ISO8528-1
14. Classe qualità ISO8528-8
15. Massima temperatura ambiente
16. Massima altitudine sul mare
17. Livello di pressione acustica al posto operatore LpA
18. Livello di potenza sonora misurato LwA
19. Livello di potenza sonora garantito LwA
20. Procedura di valutazione della conformità seguita (2005/88/CE) allegato:
21. Ente notificato preposto (2005/88/CE)
22. Peso

TECHNICAL DATA

Engine

1. Type of motor
2. Motor power
3. Displacement
4. Fuel consumption at 75% load
5. Tank Capacity
6. Oil Consumption max
7. Quantity engine oil
8. Candle type

Generator

9. AC output: rated voltage and frequency
10. AC output: rated current
11. DC output: rated voltage
12. Max power according to ISO8528 (PRP) to \cos 1
13. Class performance ISO8528-1
14. Class Quality ISO8528-8
15. Maximum ambient temperature
16. Maximum altitude sea
17. Sound pressure level at operator LpA
18. Sound power level measured LWA
19. Sound power level guaranteed LWA
20. Procedure of conformity assessment followed (2005/88 / EC) attached:
21. Notified body in charge (2005/88 / EC)
22. Weight

1	4T OHV
2	2 kW
3	105,6 cc
4	1,1 l/h
5	3,2 l
6	~ 0,2 kg ogni/every 100 h
7	0,45 l
8	A7RTC
9	230 V ~ 50 Hz
10	7,8 A
11	12 V solo carica-batterie /only battery charger
12	1,8 kW
13	G2
14	B
15	40 °C
16	1000 m
17	74,48 dB(A) K=1,07
18	94,48 dB(A) K=1,07
19	95 dB(A)
20	VI
21	Nr. 0197 TÜV Rheinland - Nürnberg - D
22	21 kg

DICHIARAZIONE DI CONFORMITÀ

La ditta indicata in etichetta dichiara sotto la propria responsabilità che il prodotto ivi citato è conforme ai requisiti essenziali di sicurezza e salute contenuti nelle seguenti direttive europee:

2006/42/CE, 2014/35/CE, 2014/30/CE, 2005/88/CE

DECLARATION OF CONFORMITY

The firm indicated on the label declares, under its own responsibility, that the product cited there complies with the essential health and safety requirements contained in the following European directives:

2006/42/CE, 2014/35/CE, 2014/30/CE, 2005/88/CE

Persona autorizzata a costituire il fascicolo tecnico presso/ The person authorized to compile the technical file is in:

Valex SpA - Via Lago Maggiore 24 - 36015 Schio (VI) - Italy

Schio, 06-2015

Un procuratore - Attorney

ARRIGO ZANELLA